

PERISTALTIC HOSE AND TUBE PUMPS

VERDERFLEX OVERVIEW

The green peristaltic
pump

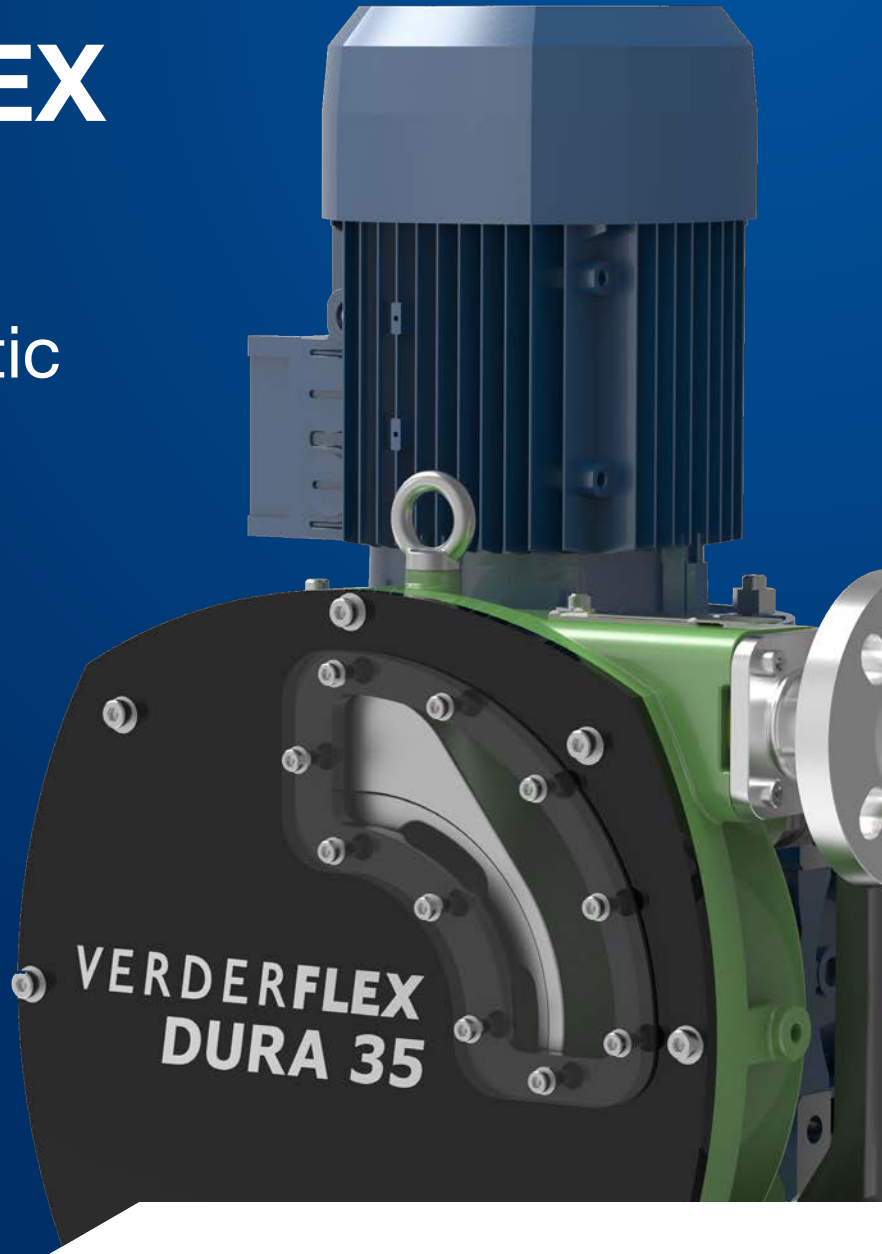

- ✓ Longest hose life
- ✓ Easy to maintain
- ✓ No product damage



*Industrial Liquid Handling Innovations
Trusted Since 1960*

ENABLING PROGRESS.

GET IN TOUCH

With the green peristaltic pump manufacturer

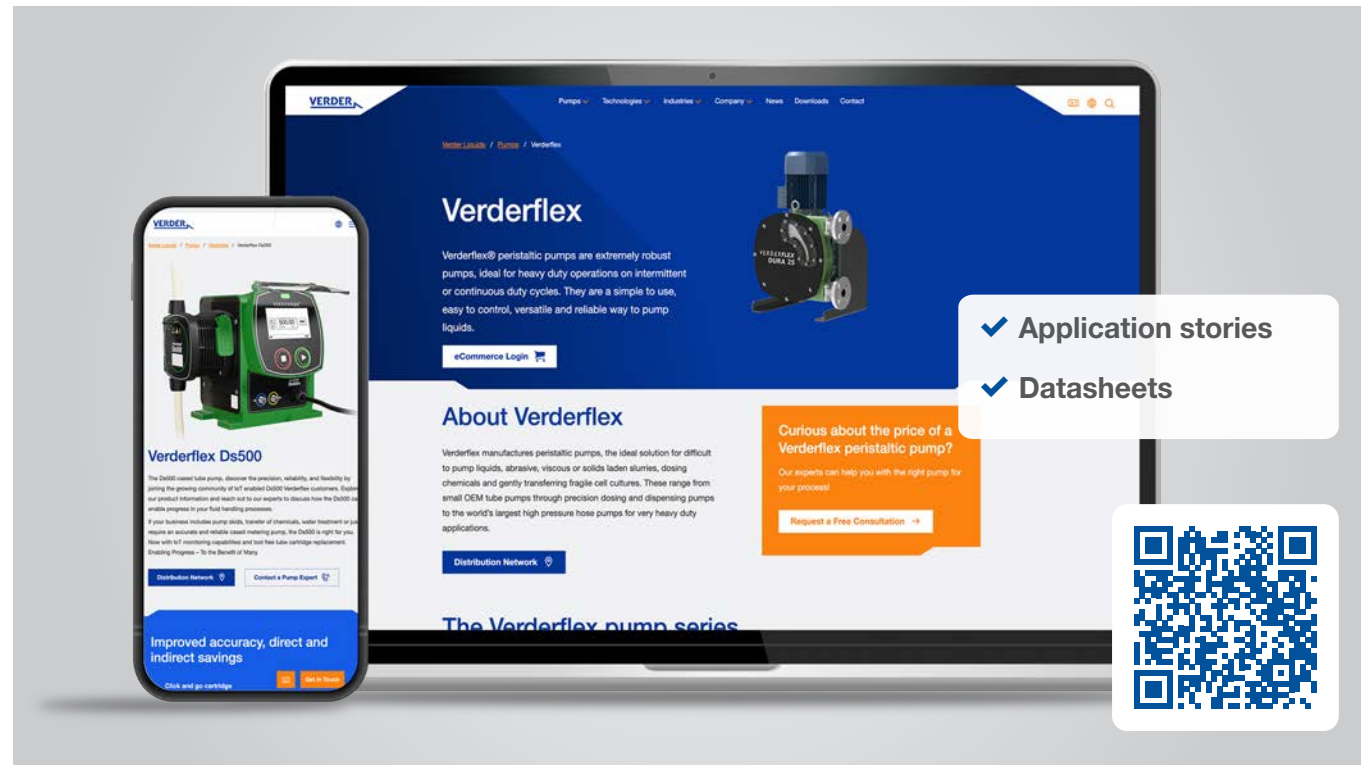

Contact Verderflex

If you would like to know more about Verderflex peristaltic pumps then please visit our website www.verderliquids.com where you will find the full breakdown of our pump range as well as application stories, latest news and technical datasheets and more.

To provide you with the best possible service Verderflex are supported by a distribution network that covers all five continents and is continuing to expand. Our group of distributors includes members of the Verder Group and experienced independent companies. Our worldwide distribution network also help to provide our customers local support and spares availability.

Verderflex® is a registered trademark of the Verder Group.

THE VERDER GROUP

Enabling progress



The VERDER group is a family-owned business formed over 60 years ago in the Netherlands; the group consists of a worldwide network of production and sales offices. Group companies are involved in the development and distribution of industrial and hygienic pump solutions, high-tech equipment for quality control and research & development into solid material (solids sample preparation and analytical technologies).

- 1 Company
- 27 Countries
- > 60 Years of expertise
- > 20 Manufacturing companies
- Global network
- Local distributors
- A solution for every application
- In-depth knowledge of processes and applications

For years, VERDER has led in innovation, driving our and our customers' success. Our global network of over 70 sales and manufacturing sites offers personalised sales and technical services, ensuring close customer relationships crucial for providing specific support and building lasting, trusting partnerships.

VERDER is dedicated to making a positive impact by aligning with the UN's Sustainable Development Goals (SDGs) through our Environmental, Social, and Governance (ESG) program. Our goal is to lessen our environmental footprint, enhance employee well-being, and uphold ethical practices.

Inventing to make the world a better place

We leverage our expertise in sample preparation, analytical equipment, and professional pumping to empower our customers. We enable progress by improving their operations. We contribute to safer, more efficient, and sustainable processes, products, and services. Our contributions are pivotal in securing safe food supplies, ensuring responsive healthcare, and safeguarding clean drinking water in millions of households.

As a united family, we embrace our societal responsibilities with passion and a commitment to excellence. Our collective efforts are aimed at fostering a healthier, safer, and more sustainable world for all.

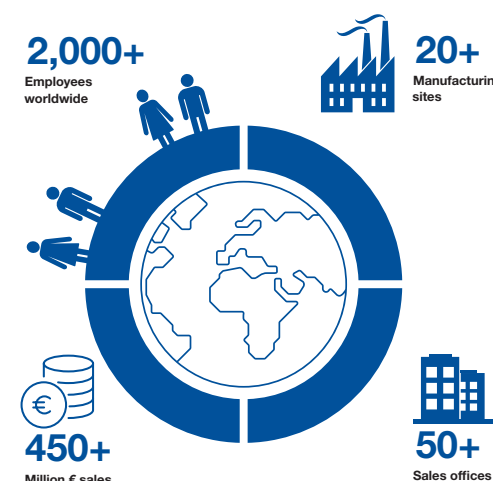

ENABLING PROGRESS.

VERDERFLEX

Hose and tube pumps



Verderflex positive displacement pumps are suitable to transfer a large variety of fluids. The liquid is totally contained within a flexible hose or tube fitted inside the pump casing. The hose or tube is the pump's only consumable part. All Verderflex pumps can be used in hygienic applications thanks to several food grade hoses and tubing.

Verderflex characteristics

- Flow rates from 1 ml/min to 90 m³/h
- Discharge pressures from 1 to 16 bar
- Ideal for pumping liquids that are abrasive, highly corrosive, shear sensitive, solids-laden high density or highly viscous
- Ideal for precise dosing and metering
- Simple designs with only the hose or tube as a consumable part
- Suction lifts up to 9.5 mWc

OPERATION PRINCIPLE

Hose and tube pumps

Peristaltic pumps work by alternating compression and relaxation of a hose/tube, drawing fluid in and propelling it away from the pump. A rotating shoe or roller passes along the length of the hose/tube creating a seal between the suction and discharge sides of the pump. As the pump's rotor turns this seal point moves along the tube or hose displacing product into the discharge line. The hose or tube recovers after the pressure has been released, creating a vacuum. This is the priming mechanism, which draws the product into the suction side of the pump.

Combining these suction and discharge principles results in a powerful self-priming positive displacement action.

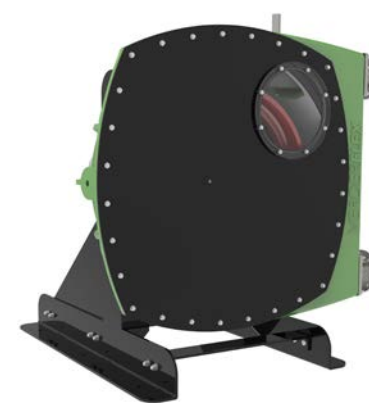

Verderflex Performance Overview

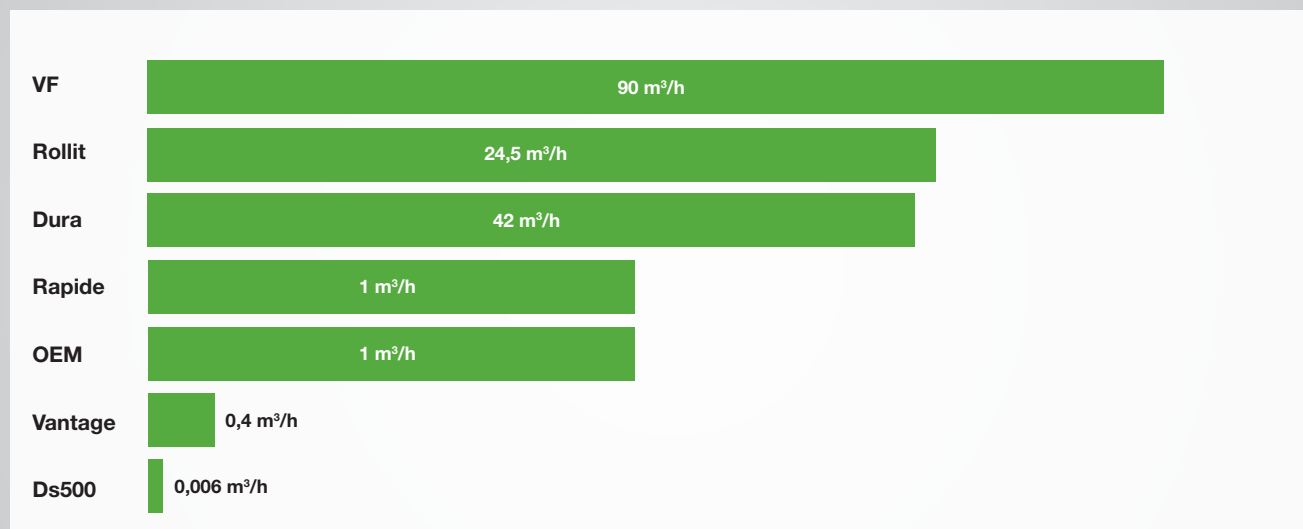

What are your benefits using a Verderflex pump?

Longest hose life

- Extended service intervals - maximum fatigue strength for longest hose life
- Abrasion resistant: no worn parts
- Can pump air: eliminates vapour locking downtime
- Dry running: No internal pump damage
- Minimal service time: Fast hose or tube changeovers in minutes

Easy to maintain

- Only 1 service part: the easy to change hose or tube
- Service in situ: no need to remove the pump to a workshop
- Simple design: no complex sealing arrangements
- No additional seals or valves eliminating additional equipment

No product damage

- Minimises chemical usage: Retain polymer monomer chains
- Maximises process recovery: live cell concentrations preserved
- Gentle pumping action: low velocity, no product degradation
- Low product shear: Protect soft crystals, carbon particles, product such as live fish in transfer

THE VERDERFLEX PROGRAM

An overview



VERDERFLEX DURA

Compact, low to medium flow high pressure pump. The Verderflex Dura is the most compact peristaltic pump in the market. Thanks to the innovative design the footprint can be reduced up to 70%, optionally in an ATEX rated format.

Max. Flow	42 m ³ /h
Max. Pressure	16 bar

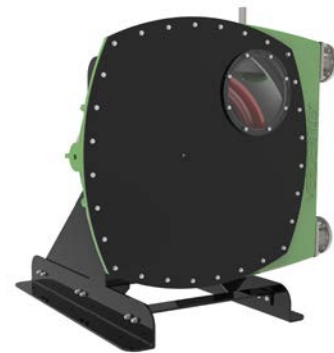

VERDERFLEX VF

Powerful high flow, high pressure pump. Robust Verderflex VF hose pumps are excellent for pumping viscous, high density abrasive or corrosive fluids and can be ATEX certified.

Max. Flow	90 m ³ /h
Max. Pressure	16 bar



VERDERFLEX ROLLIT

Lubricant free, low pressure, low power pump. The lubricant free pump for high flow rates and low power consumption. Available with single or twin head, 2 or 4 bar pressure and as hygienic version.

Max. Flow	24.5 m ³ /h
Max. Pressure	4 bar



VERDERFLEX DS500

Dosing and metering pump with asset management IoT software. The click on low pulsation cartridge contain the fluid in the event of hose failure and allow the pump to be ready for service within minutes. The pump is suitable to transfer various chemicals in the industrial water treatment environment, 4-20mA allow for precise control.

Max. Flow	500 l/min
Max. Pressure	7 bar

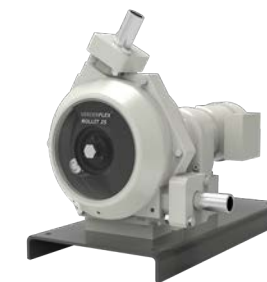

ROLLIT HYGIENIC

Single use tubing, no risk of contamination. The hygienic Rollit pump is a lubrication free roller pump, FDA and EN 1935 certified perfectly suited to hygienic applications. The dry casing allow for contamination free quick hose changes to bring the pump back to service in minutes.

Max. Flow	6.954 l/h
Max. Pressure	2 bar



VERDERFLEX OEM

Custom system integration solutions. Verderflex OEM pumps offer a selection of custom pump designs, motor options and tubing. The range can be configured into an optimal solution for any OEM pump requirement.

Max. Flow	17 l/min
Max. Pressure	2 bar



VERDERFLEX VANTAGE

Precision controlled dosing. The innovative Verderflex Vantage is a very precise, controllable dosing system with a USB back-up. Ideal for batch dosing and accurate dispensing. Asset management IoT software, provide remote access to pump data while the pump is MODBUS, PROFIBUS and SCADA capable in addition to the standard 4-20mA.

Max. Flow	6.6 l/min
Max. Pressure	7 bar

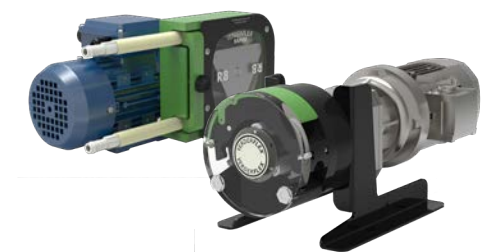

VERDERFLEX RAPIDE

Simple low pressure industrial dosing. These simple IP 55 industrial style pumps can be comfortably integrated into existing equipment. They are ideal for liquid transfer and can be easily controlled by external inverters (VFD's).

Max. Flow	17 l/min
Max. Pressure	2 bar

HOSES AND TUBES

The heart of your peristaltic pump



The Verderflex hose can reach up to 15 million compressions, made possible by the unique designed resistance to fatigue. Thanks to the hose design the Verderflex hose offers many advantages:

- Longest hose life
- Superior mechanical strength
- Controlled manufacturing
- Superior lubrication and cooling
- Retain extreme high accuracy



Hoses for DURA/VF pumps



NR - Natural rubber

The most widely used hose in all market segments is made of natural rubber. Both inner layer and outer surface are made of natural rubber and very resistant to abrasion. Suitable for use with slightly corrosive chemicals, very abrasive slurries, inorganic products, etc.

Temperature	-20 to +80 °C
Colorcode	White
Max. Pressure	16 bar



NBR - Nitrile-Buna rubber

This hose is particularly suitable for oily, greasy or organic products. The inner lining is made of nitrile butadiene rubber, the outer lining is a mixture of styrene-butadiene rubber and natural rubber.

Temperature	-20 to +80 °C
Colorcode	Yellow
Max. Pressure	16 bar



NBRF - Food Grade Nitrile Buna rubber (FDA)

The NBRF hose has an inner lining suitable for FDA compliant applications or those with a similar high hygienic standard. The low spallation hose is suitable for FDA, EC 1935 compliance.

Temperature	-20 to +80 °C
Colorcode	white / yellow
Max. Pressure	16 bar



EPDM

This hose is particularly suitable for corrosive chemicals and inorganic compounds. Unlike many other EPDM hoses, the homogeneous Verderflex EPDM hose is made totally from EPDM, making the hose extremely resistant to corrosive chemicals and ideal for working at elevated temperatures.

Temperature	-20 to +100 °C
Colorcode	Red
Max. Pressure	16 bar



CSM - Hypalon®

The CSM or Hypalon® hose is used when highly corrosive media, e.g. strongly oxidizing media, must be transferred. The inner layer is made of CSM, the outer surface of SBR / NR. Hypalon is a trademark of DuPont™.

Temperature	-20 to +85 °C
Colorcode	Green
Max. Pressure	16 bar



VP - Verderprene

This opaque, cream coloured hose provides a food grade, low-spallation hose for the Dura pump suitable for FDA compliance.

Temperature	+5 to +80 °C
Colorcode	Beige
Max. Pressure	3 bar



Hoses for ROLLIT pumps



NR - Natural rubber

Natural rubber is a highly abrasion resistant, general purpose hose material, ideal for use on slurries and pastes.

Temperature	+5 to +60 °C
Max. Pressure	2/4 bar
Max. temperature	80 °C short term

FN - Food Grade Natural rubber

The Food Grade Natural rubber hose complies with FDA CFR 21 and is ideal for food and drink applications requiring such certification.

Max. temperature	60 °C continuous
Max. Pressure	2 bar
Max. temperature	80 °C short term

VP - Verderprene

The Rollit's Verderprene hoses are designed specially for use in the low pressure, 2 bar Verderflex Rollit Hygienic pumps. These low spallation loss, food grade hoses comply with FDA CFR21 and EC/1935.

Max. temperature	80 °C continuous
Max. Pressure	2 bar
Max. temperature	95 °C short term

Neoprene (CR)

Neoprene is an alternative hose material useful when pumping more oily liquids.

Temperature	+5 to +60 °C
Max. Pressure	2 bar
Max. temperature	80 °C short term



HOSES AND TUBES

The heart of your peristaltic pump

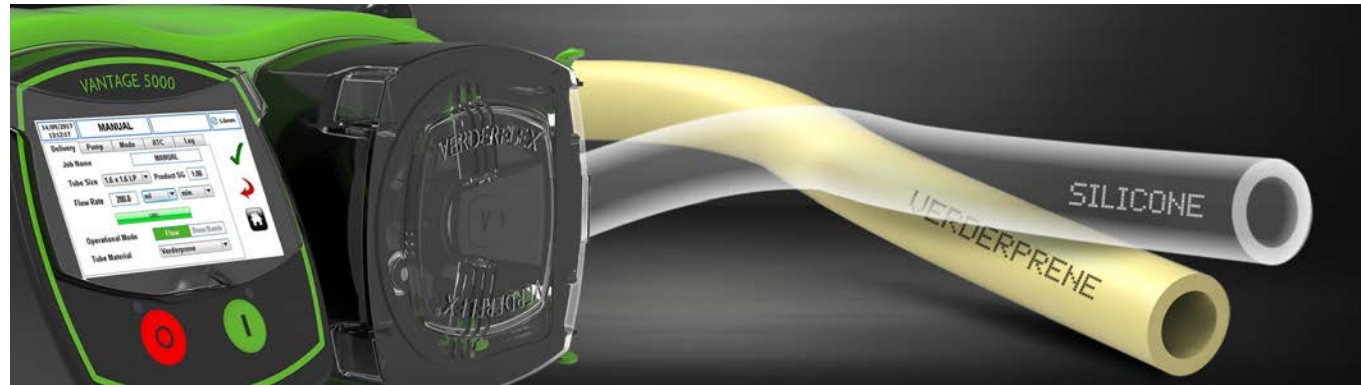

Verderprene

Most popular choice for tube pumps (FDA or NSF compliant depending on pressure).

Temperature	+10 to +85 ° C
Colour of the label	Natural/Beige
Max. Pressure	3 bar
Compliance	FDA or NSF



Silicone

Platinum cured Silicone is a translucent, odourless tubing with low residuals (FDA & USP compliant).

Temperature	-20 to +85 ° C
Colour of the label	Translucent
Max. Pressure	3 bar
Compliance	FDA, USP

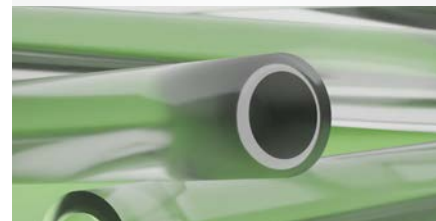

Verderhygienic

Verderhygienic tubing will not crack or deteriorate. Extremely flexible, it resists kinks and retains its shape.

Temperature	-80 to +135 ° C
Colour of the label	White
Max. Pressure	3 bar
Compliance	FDA, RoHs



Verderchem

Chemical resistant inner liner allows for a broader range of usability. Virtually unaffected by acids, bases, salts, ketones and alcohols.

Temperature	-60 to +74 ° C
Colour of the label	Cream
Max. Pressure	3 bar
Compliance	FDA, RoHs



Other materials including chemically resistive grades of Tygon® and Viton® are available on request.

LUBRICATION AND ACCESSOIRES

Optimize your pumps performance

Lubrication

Peristaltic hose pumps use a lubricant bath to help the hose dissipate the energy stored in the re-enforcing layers and require lubrication to optimize pump performance. Verderlube (glycerine based) is the standard lubricant for Verderflex pumps. When strong oxidisers or nitrogenous chemicals are pumped Verder also offers Verdersil, a silicone based lubricant that is also suitable for higher temperatures.

Both lubricants are purpose designed to work with Verderflex hose pumps acting as a lubricant and coolant for efficient pumping and prolonged hose life. For dry running pumps, including the Verderflex Rollit, Verderflex provides a range of lubricant greases including standard, NSF food grade and Silicone free options.



Accessories

Verder supplies pumps equipped with many accessories, quick change connector hoses and lances, revolution counters, hose bursts detection device, pulsation dampeners, filler tubes and flange inserts for chemical and abrasive products.

Sensor - A calibrated sensor recognizes a rise in pressure. Once the pressure limit is reached the sensor changes the status, and an alarm will be sent and/or the pump can be shut-off automatically, preventing damage.

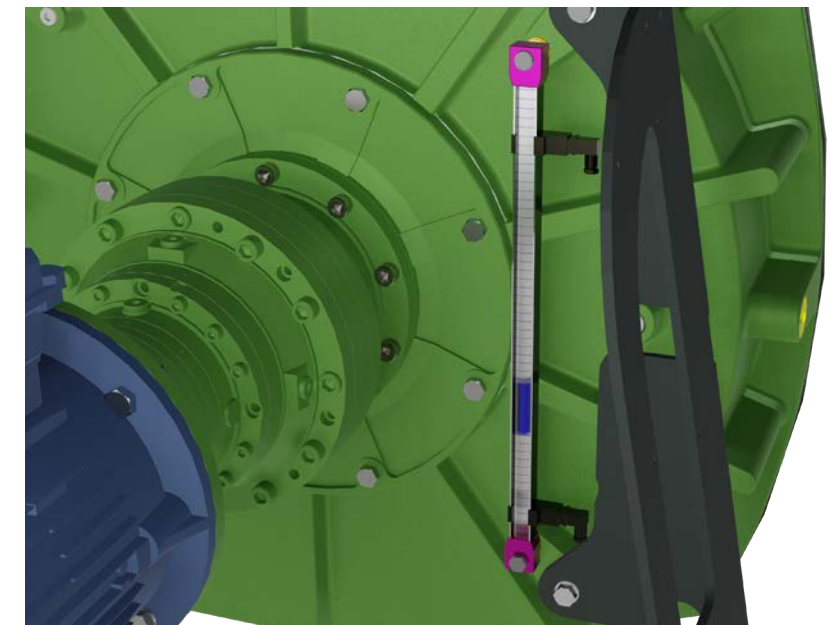

VERDERFLEX DURA

The compact solution

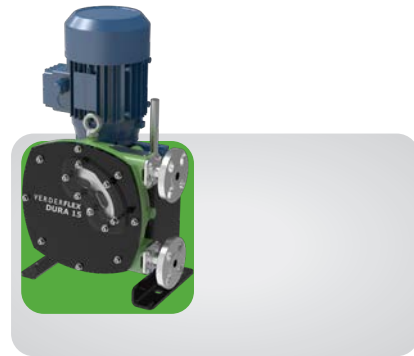

Footprint
70%
smaller than
competition

The Verderflex Dura is the first real innovation in hose pump technology since the high pressure hose was developed. Combining the compactness of a close coupled pump with all the benefits of the traditional long coupled pump, the Verderflex Dura offers new application possibilities.

Features of the Verderflex DURA 5 - 80 hose pumps

- Space saving footprint
- Very robust one piece rotor
- Special 5 and 7 mm hoses for high pressure, low volume applications
- Timesaving and easy hose change with a simple taper fit flange assembly
- Polypropylene and PVDF insert options for aggressive chemicals
- Safe: Gearbox is totally isolated from pump head

Features of the Verderflex DURA 45 - 80 hose pumps

- Drain channel for gearbox protection
- Fully supported shimmable rotor shoes
- Independently supported rotor (D45 - D 65)
- Optional burst detection and liquid level indicator tube

Technical details

Max. Flow rate	42 m ³ /h
Max. Discharge pressure	16 bar
Dry Suction Lift	< 9.5 mwc
Options	ATEX



The innovative Dura gearbox mounting design

- Zero possibility of cross contamination: gearbox and pump body are totally separated
- Simple and safe: the gearbox's hollow shaft slides on to the pump's drive shaft and is locked in place with a key
- Reliable high-rigidity gearbox mounting

Quick and easy hose replacement

- Advanced hose clamping design simplifies hose replacement
- Secure: hose is totally enclosed inside pump casing
- The innovative conical flange nozzle compresses the hose against the housing taper to form a perfect seal
- Chemical and abrasive resistant inserts are available in PP and PVDF
- Flexibility: universal flange mates with DIN, ANSI and JIS pipe work

Bearing supported rotor

- Extended gearbox lifetime: rotor is centrally located over its support bearings
- Reduced maintenance: sealed for life bearings
- Lower maintenance cost: stalled rotor protection minimises damage from plugs and chokes

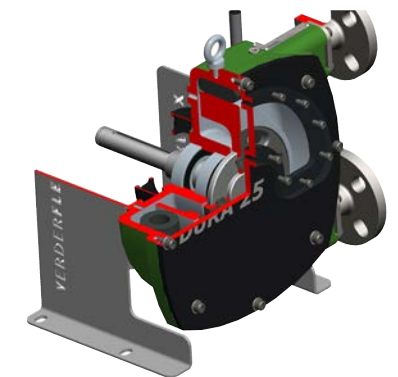

iDura, the complete solution

Hose pump + integrated IP 66 inverter + integral hose burst sensor

Every iDura comes with built-in flow rate flexibility – the inverter allows the pump flow rate to be easily increased or decreased to accommodate production variations.

- ✓ Pre-programmed with the iDura size's flow range
- ✓ The inverter's potentiometer's easily sets the flow range, or the built in 4 – 20 mA input provide a remote control option
- ✓ MODBUS and CANBUS connectivity
- ✓ Asset management IoT software for real time remote access of pump and duty data



VERDERFLEX VF

For powerful heavy duty applications



The Verderflex VF range of industrial hose pumps are a proven, medium to high flow, high pressure, heavy duty abrasion resistant family of peristaltic pumps. Capable to pump high solid content (up to 80%) and high density (specific gravity), reducing water usage and improving process efficiencies. These field proven VF pumps offer a reliable solution in difficult pumping situations worldwide. Replacement VF hoses typically cost just around 10% of the initial pump price - the long life hose is rapidly replaced in situ without removing the pump to a workshop, saving time, money and frustration.

Features of the Verderflex VF hose pumps

- Flow rates up to 90 m³/h
- Rigid pump housing design for heat dissipation and strength
- Fit-in hoses; no adjustment needed, quick return to service time
- Minimise maintenance costs 100% volumetric flow
- The accurate and 100% volumetric flow reduce operational cost
- Lower installed power over competing technologies

Technical details

Max. Flow rate	90 m ³ /h
Max. Discharge pressure	16 bar
Max. Dry Suction Lift	9.5 mwc
Options	ATEX

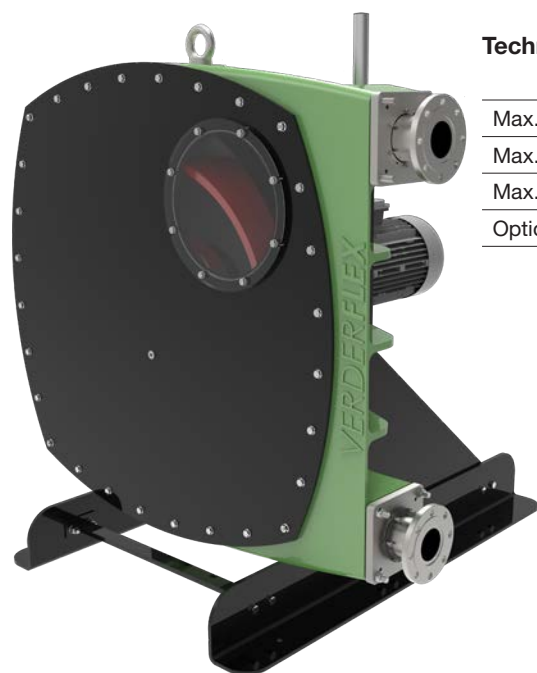

Rotors and Rotor Shoes

Each rotor shoe's compression and the associated hose occlusion can be custom configured using shims to closely match the pump's operating back pressure optimising the balance between hose compression and hose life. This simple combination readily withstands the ingress of pumped product on a hose burst unlike the complex bearing and seal arrangements used by roller assemblies.

Options

- ATEX versions
- Hose burst monitoring
- Optional hygienic connections to standards including Tri-clamp and Dairy
- Pulsation dampers
- Screw on sherardized (vapour galvanised) universal flanges for the VF100 and VF125
- Special coatings for corrosion protection
- Stainless steel Rotor shoes and base frame
- A range of pulsation dampeners



Precise alignment between system pressure and hose

Every Verderflex Dura 45 to VF 125 pump has 2 diametrically opposed rotor shoes, normally precision cast aluminium, fitted on their robust cast iron rotor. These large radius of curvature shoes provide a gentle, gradual transition between full hose closure, compression and total hose relaxation, minimising the hose's re-enforcement fibre stress and helping maximise hose life unlike the harsh compression of small radius roller options.

The rotor shoe design and larger surface area enable a higher compression force applied to the hose to create a compression seal suitable to withstand system counter pressure as high as 16 bar.



VERDERFLEX ROLLIT

The smooth flowing pump



The Verderflex Rollit is a series of easy to use, lubricant free hose pumps for flow rate up to 24.5 m³/h. Easy to maintain, with 3 rollers for low pulsation. Energy efficient Verderflex Rollit pumps are dry self-priming capable of up to 8 mwc negative suction head and are available as single and twin pump head/hose options.

The Rollit is available as high pressure version with up to 4 bar or as a twin head pump at 2 bar pressure. The Rollit pumps are also available with a hygienic hose which meets the requirements of FDA and is certified to EN1935.

Features of the Verderflex ROLLIT hose pumps

- EC & FDA Food grade hoses
- Hose changeover takes less than 3 minutes
- A dry casing pump
- No seals, flaps and valves
- Optional ATEX versions
- Self-priming up to 8 mwc lift
- Standard & low pulsation Twin pump head options

Technical details

Max. Flow rate	24.5 m ³ /h
Max. Discharge pressure	4 bar
Max. Motor power	4 kW
Max. Pump speed	165 rpm
Max. Dry Suction Lift	8 mwc
Options	ATEX

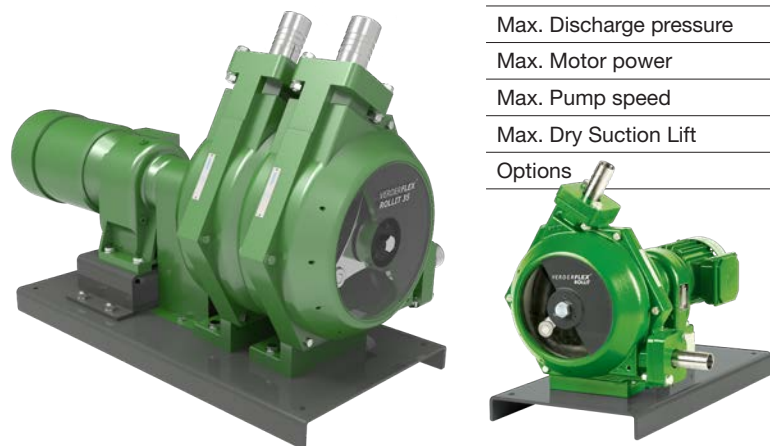

VERDERFLEX RAPIDE

Simple to operate



The Verderflex Rapide is a series of compact, simple to operate, low to medium flow, low pressure peristaltic pumps. Tube changeovers require no special tools, for fast, very easy tube changeovers.

Features of the Verderflex RAPIDE pumps

- Compact size
- Simple control systems using variable frequency drives (VFDs) or inverters for variable flow applications
- Fast tube change
- Easy integration into third party equipment, such as printing presses
- Duplex versions available

Technical details

Max. Flow rate	17 l/min
Max. Discharge pressure	2 bar



VERDERFLEX VANTAGE

Exact dosing for your process



The Vantage is a compact, precise dosing pump. It offers precision repeatable dosing for low and medium flows at low and medium pressures. Pumps can be remotely controlled using a range of industry standard protocols (Modbus, Profibus or SCADA) and can be used to reliably dose single volumes or cyclically dose the same volume from remote controllers such as footswitches or using the pump's own controls. The Vantage 5000 pump excels with precision batch dosing and dispensing applications, the pump remains accurate to the target flow. The asset management IoT remote access software allow the operator to remain connected to the pump duty and performance parameters.

Vantage 5000

The Verderflex Vantage 5000 dosing pumps is fitted with an advanced touch screen, jobs and pump historic pump data can be downloaded or new programs uploaded via the USB port. The Vantage 5000's flow ranges a tiny 70 µl/min up to 6600 ml/min.

Technical details

Max. Flow rate	6.600 ml/min
Max. Discharge pressure	7 bar



Benefits

- Easy to use: set up the pump in seconds using intuitive icon based menus
- Flexibility: Analogue Remote control options include 4 to 20mA, 0-10V (Modbus, Profibus and/or SCADA)
- Local memory: each pump stores up to 30 dosing programs
- Precision metering: 4000: 1 turndown
- Protection: USB backup of programs and Pump History
- Remote Monitoring with the Verderflex asset management IoT software
- Secure: Multi Level Password Access

Verderflex Vantage 3000

These pumps are perfect for laboratory applications such as dosing low volumes of shear sensitive fluids. Different models have different capabilities including simple manual transfer, remote control using external signals or switches or programmable dosing. Some of the models can be equipped with multiple heads for multi-channel pumping requirements.

Your benefits

- Easy tube change in seconds
- Economic manual transfer version
- Programmable dosing
- Remote speed control options: 0-10V, 4-20mA and potentiometer inputs
- Simple keyboard programming

Technical details

Max. Flow rate	3,25 l/min
Max. Discharge pressure	2 bar



VERDERFLEX Ds500

A new horizon for peristaltic dosing and metering



Applications areas

- Industrial water treatment
- Metering and dosing
- Disinfectants
- Pigments
- Acids/Alkalies
- Cleaning agents
- Sampling
- Flocculants
- Additives

The Ds500 metering and dosing pump has been designed specifically for industrial water treatment applications and other accurate metering and dosing applications. The principle behind this technology is to improve the accuracy and save the end user money with both direct costs and indirect costs by minimal tool free maintenance and servicing.

Benefits of the Verderflex Ds500

- High accuracy for metering and dosing - saves chemical consumption
- Tool free cartridge change for service - quick and easy
- Touchscreen control panel for easy set up and use

Technical details

Flow rate	0.1 - 500 l/min
Discharge pressure	Max. 7 bar



REMOTE ASSISTANT IOT

What can the Ds500 do for you?

The Remote Assistant supports asset management monitoring but does not allow you to control the pump. It ensures accuracy in your process that allow access to real time pump data to, plan maintenance and prevent downtime (alerts on problems).

Support and service

On hand support and online aftermarket parts and services.



Tube life prediction

Machine learning can harness the 'intel' from your system of pumps to help predict tube/cartridge life before failure and allow efficient maintenance planning.

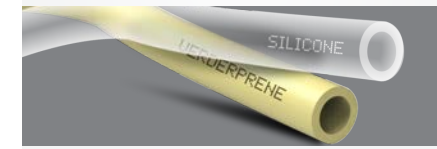

Operator assistance

Operator safeguarding via RA alarms covering all critical functions, such as tube failure.



Operation flexibility

Allows the user to monitor or define operating boundaries and be alerted via RA when the pump deviates or exceeds.



Asset monitoring

Real time equipment monitoring via the RA App from a simple 'is it running?' to complex data analysis and recording.



Maintenance planning

Cartridge life countdown function empowers the operator to plan maintenance around operations and reduce component changeover and plan sufficient part stocking.

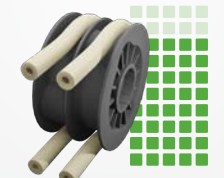

Benefits at a glance

- ✓ Click and go cartridge
- ✓ Smoothed flow for improved dosing
- ✓ Touchscreen for easy control
- ✓ Connections for remote control
- ✓ Small footprint with secure mounting
- ✓ Asset management IoT remote access software



VERDERFLEX OEM PUMPS

To build in your system



- ✓ Great flexibility thanks to many tube options
- ✓ Industrialized versions for demanding applications
- ✓ Quick and easy tube changeovers
- ✓ Multiple heads pump options

Our OEM Product Range offers a selection of custom pump designs, motor options and tubing. The Verderflex OEM range can be configured into an optimal solution for any OEM pump requirement.

Verderflex M-Series

The Verderflex M-series pumps are a simple, family of well proven solutions suitable for integration in dosing, dispensing, vending, transfer and bottle filling systems. Normally used for low flow dosing, the pump range offers a wide range of flows up to 17 l/min. Available with different motor specifications depending on application e.g. commercial vending, hygienic or dirty industrial and extraction environments.

The M60 pump head has a snap-on tube assembly for rapid tube changeovers.

Verderflex Miniload & EZ

The Verderflex Miniload and EZ head are “flip top” pump head pumps with a quick and easy tube change system. They can be stacked for multi-channel pumping. Motor options include permanent and brushless D.C. or the Steptronic precision drive for custom speed/flow rate configurations.

Innovative: Verderflex Steptronic Drive

The Verderflex Steptronic configurable drive is a programmable brushless stepper motor with a 12 bit analogue resolution and 4-20 mA or 0-10 V speed control inputs. With a maximum speed of 400 rpm and a speed accuracy of 0.1 % it's perfect for all precision dosing applications using the M60, Miniload or EZ pumpheads.

Flow range	0 - 1,310 ml
------------	--------------



VERDERFLEX VP PUMPS

Peristaltic pumps for the small flow dosing



Verderflex VP peristaltic pumps are perfect for low flow dosing with timer, pH or redox control options. The pumps are self priming, with an innovative stable flow control to maximise tube life. Typical applications are dosing chemicals or cleaning agents for original equipment (OEM) manufacturers of washing machines, dish-washers and beverage machine dispensers. Other common application areas are in the chemical industry, medical industry, laboratory and analysis, swimming pools, cleaning and hygiene.

Verderflex VP, Verderflex VP Dual and Verderflex VP Pro series pumps

Compact Single channel Verderflex VP peristaltic tube pumps have models with integrated dosing functions such as timer, pH control or Redox control. The easy to program and maintain Verderflex VP Dual series are compact all in one solutions for monitoring widely varying water parameters including pH, Redox, Chlorine and temperature via built in instruments that adjust dosing rates in response to parametric changes.

Max. flow	30 l/h
Max. discharge pressure	3 bar

The 3 Verderflex VP Pro versions provide pH / Rx, mA and Cl monitoring with extended, digital and proportional dosing; variable speed control options, adjustable setpoint alarms and switch on time delays.

Max. flow	6 l/h
Max. pressure	1 bar

Verderflex VP Pre- Assembled Panels

Verderflex VP ready to use panels have several Verderdos and Verderflex pumps mounted, complete with all accessories. The compact, fast set-up IP65 panels have easy to reach connections and simple sliding brackets for quick and easy pump replacement.

- ✓ Compact low flow dosing pumps
- ✓ Choice of different water parametric control options
- ✓ Large number of product options to suit many applications
- ✓ OEM systems proven



VERDERFLEX HYGIENIC PUMPS

High accuracy - no risk of contamination



- ✓ High accuracy
- ✓ Interchangeable tubing
- ✓ Lubricant free
- ✓ End-to-end control

Verderflex peristaltic pumps are manufactured in ISO 9001, ISO 14001 and ISO 18001 accredited facilities in Germany and the UK. Verderflex pumps are used for precise, gentle, aseptic transfer of shear sensitive cultures, nutrient dosing, inter-reactor transfer using USP VI rated tubing.

The Vantage 5000 combines precision dosing with advanced compliance assistance including time stamped record keeping, security from USB backed up settings and records and reassurance of real time feedback and control to master controllers and PLCs. It is a perfect solution for precise and controlled single or batch inline dosing/filling applications.

The Rollit hose pumps are lubrication free. This gives advantages in food and pharma applications because there is no contamination possible; even extending to our new Rollit Thru which gives the option of larger bore continuous tubing in this range of pumps allowing end-to-end process control.

High accuracy

The peristaltic range gives the options of easy batch tube change, minimum maintenance, and with the Vantage 5000 up to +/- 1% accuracy on a fully controlled dose/metering or transfer application for Single Use Tubing.

Interchangeable tubing

Our tubing is interchangeable with all other major tubing suppliers as long as the ID/OD and properties are similar.

VERDERFLEX HYGIENIC PUMPS

Models to choose from



VANTAGE 5000 hygienic

Precision dosing and dispensing accuracy with high discharge pressures, intuitive touch screen user interface and a USB data backup port.

Technical details

Flow rate	6.600 ml/min
Max. Discharge pressure	7 bar



ROLLIT hygienic

Without a lubricant bath Verderflex ROLLIT Hygienic pumps are ideal for use in biotechnology, beverage production, food processing and the pharmaceutical industry.

Technical details

Max. Flow rate	6.954 l/h
Max. Discharge pressure	2 bar



RAPIDE hygienic

Simple low pressure industrial dosing. Ideal for liquid transfer and easily controlled by external inverters (VFD's).

Technical details

Flow rate	17 l/min
Max. Discharge pressure	2 bar

Certifications



VERDERFLEX APPLICATIONS

A pump solution for every application

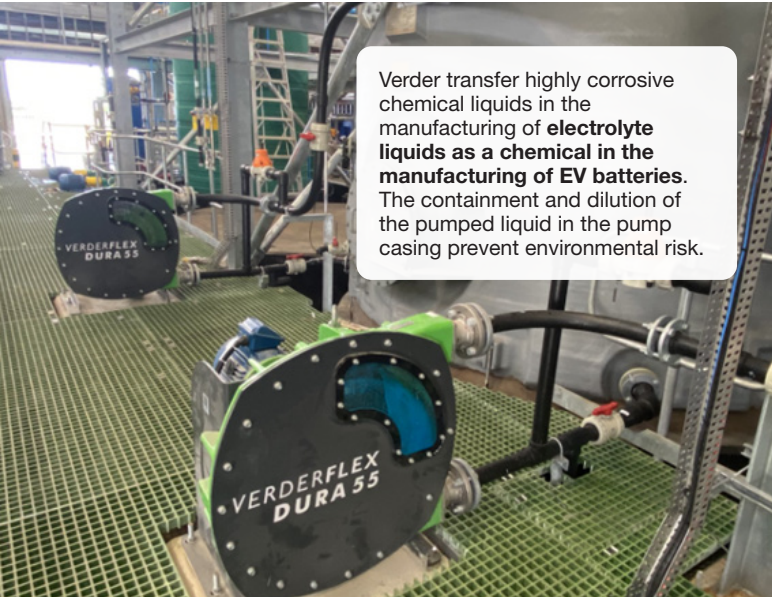

Verder transfer highly corrosive chemical liquids in the manufacturing of **electrolyte liquids as a chemical in the manufacturing of EV batteries.** The containment and dilution of the pumped liquid in the pump casing prevent environmental risk.



Transferring High Solids Mining Slurry - VF100 & VF125 pumps earned a reputation as the mining industry's slurry pumping workhorse. They excel pumping high SG slurries with up to 80% fine solids content and minimal abrasive wear.



Pumping Kieselguhr - Several Dura 25s dose and transfer Kieselguhr (Diatomaceous Earth or Diatomite) at a Bavarian brewery, filtering 1200 hl of beer in every 8-10 hour cycle.



Dura 35 pumps installed to **dose flocculent to treat industrial water** on a process plant. Dura peristaltic pumps was selected over helical screw pumps due to the superior protection and low shear ability of the technology.



Dosing Alum - Eight Rapide R17S dose Aluminium Sulphate to purify drinking water. These Rapides replaced problem high maintenance cost solenoid operated pumps giving more consistent dosing performance.

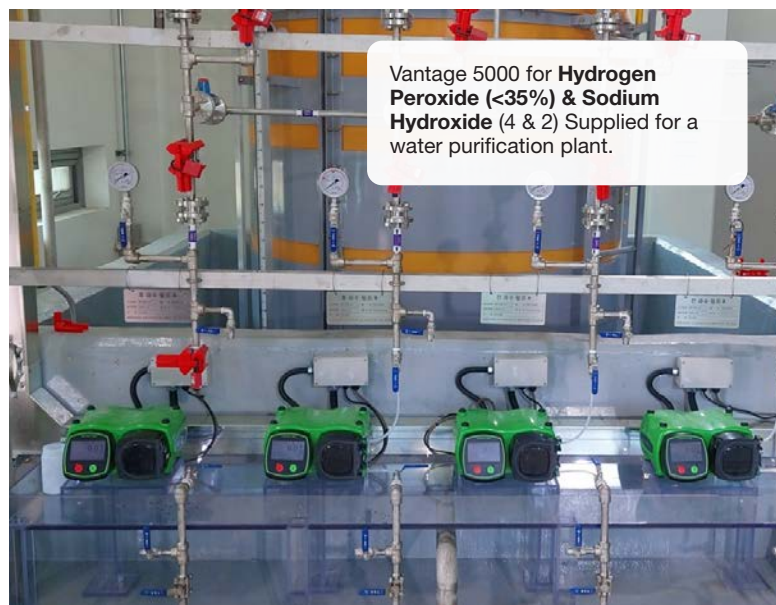

Vantage 5000 for **Hydrogen Peroxide (<35%) & Sodium Hydroxide (4 & 2)** Supplied for a water purification plant.





VERDER LIQUIDS

The leading
pump
manufacturer

VERDER
passion for pumps

Exclusively distributed by:



Industrial Liquid Handling Innovations
Trusted Since 1960

2 Westwyn Court, Brampton, ON, L6T 4T5
Tel: (905) 454-4013
Email: sales@yorkfluid.com
www.yorkfluid.com